

Spectrum Management

Spectrum Utilization Policy

Revisions to Microwave Spectrum Utilization Policies in the Range of 1-20 GHz

Notice No. DGTP-002-95**Amended by:**

- DGTP-006-99 Amendments to the Microwave Spectrum Utilization Policies in the 1-3 GHz Frequency Range (October 1999)
- DGTP-006-97 Proposals to Provide New Opportunities for the Use of the Radio Spectrum in the 1-20 GHz Frequency Range (August 1997)
- DGTP-007-97 Spectrum Policy Provisions to Permit the Use of Digital Radio Broadcasting Installations to Provide to Non-Broadcasting Services (September 1997)
- DGTP-004-97 Licence Exempt Personal Communications Services in the Frequency Band 1910-1930 MHz (April 1997)
- DGTP-005-95 / DGRB-002-95 Policy and Call for Applications: Wireless Personal Communications Services in the 2 GHz Range, Implementing PCS in Canada (June 1995)
- DGTP-007-00 / DGRB-005-00 Policy and Licensing Procedures for the Auction of the Additional PCS Spectrum in the 2 GHz Frequency Range (June 2000)
- DGTP-003-01 Revisions to the Spectrum Utilization Policy for Services in the Frequency Range 2285-2483.5 MHz (June 2001)
- DGRB-003-03 Policy and Licensing Procedures for the Auction of Spectrum Licences in the 2300 MHz and 3500 MHz Bands (September 2003)
- DGRB-006-99 Policy and Licensing Procedures - Multipoint Communications Systems in the 2500 MHz Range (June 1999)
- DGTP-004-04 Revisions to Allocations in the Band 2500-2690 MHz and Consultation on Spectrum Utilization (April 2004)
- DGTP-008-04 Revisions to Spectrum Utilization Policies in the 3-30 GHz Frequency Range and Further Consultation (October 2004)
- DGTP-006-03 Expansion of Spectrum for Fixed Wireless Access in the 3500 MHz Range (April 2003)
- DGTP-002-03 Restructuring the Spectrum in the Band 3400-3650 MHz to More Effectively Accommodate Fixed and Radiolocation Services (February 2003)
- DGTP-013-98 Spectrum Policy and Licensing Provisions for Fixed Wireless Access Systems in Rural Areas in the Frequency Range 3400-3700 MHz (July 1998)
- DGTP-001-97 On the Modification of Microwave Spectrum Utilization Policy Provisions for the Band 7125-7725 MHz and the Release of the Standard Radio System Plan (SRSP-307.1, Issue 4) (January 1997)

Table of Contents

Notice No. DGTP-002-95	1
Part A	
Revisions to Microwave Spectrum Utilization Policies in the Range of 1-20 GHz	2
1. Background	2
1.1 Introduction	2
1.2 Spectrum Allocation	2
1.3 Spectrum Utilization	3
1.4 Technical Standards and Licensing Aspects	4
2. Policy Development Considerations	4
2.1 The Fixed Service	4
Part B	
Revisions to the Microwave Spectrum Utilization Policies in the Range of 1-20 GHz	7
1. Policy Conclusions	7
1.1 Background	7
1.2 Relationship Between Spectrum Allocation and Utilization Policies	7
1.3 Re-accommodation of Existing Fixed Systems and the Introduction of New Personal Communications Services and Terrestrial Digital Radio Broadcasting	8
1.4 Industrial, Scientific and Medical (ISM) Devices	10
1.5 Very Low Capacity (VLC) Fixed Systems	10
1.6 Geographical Differences Policy Guideline	10
1.7 Reducing Types of Use	12
1.8 Path Lengths	12
1.9 Fixed System Capacities	12
1.10 Non-Spectrum and Spectrum Alternatives	13
1.11 Frequency Diversity	14
1.12 Overall Carriage Capacity and Spectrum Efficiency	14
2. Spectrum Utilization Policies for Certain Frequency Bands	15
1350 - 1400 MHz	16
1427 - 1525 MHz	17
1700 - 2010 MHz	19
2010 - 2300 MHz	21
2300 - 2690 MHz	23
3500 - 4200 MHz	25
4400 - 5000 MHz	26
5850 - 6425 MHz	27
6425 - 7125 MHz	28
7125 - 7725 MHz	29
7725 - 8275 MHz	31
8275 - 8500 MHz	32

10.5 - 10.68 GHz	33
10.7 - 11.7 GHz	34
12.7 - 13.25 GHz	35
14.5 - 15.35 GHz	36
17.7 - 19.7 GHz	37
21.2 - 23.6 GHz	38
3. Implementation	39
Annex A	40

Notice No. DGTP-002-95

This notice announces revisions to the microwave spectrum policies for Canada with the release of the policy document entitled, *Revisions to Microwave Spectrum Utilization Policies in the Range of 1-20 GHz*.

In the Spring of 1993, Industry Canada initiated a comprehensive Spectrum Policy Review in part to take advantage of the new frequency allocations made by the 1992 World Administrative Radio Conference (WARC-92), in which Canada was an active participant, and to accommodate the increasing demand for spectrum by existing and emerging radio services. Five public documents making proposals on specific spectrum allocation and utilization issues were released to provide the basis for wide public consultation. In particular the document entitled Proposed Spectrum Utilization for Certain Services Above 1 GHz (DGTP-005-93) addressed spectrum policy revisions for most of the fixed service frequency bands in the range 1-20 GHz.

Based on the extensive public comments received and findings from public meetings organized by industry, Industry Canada is now issuing *Revisions to Microwave Spectrum Utilization Policies in the Range of 1-20 GHz* to reflect the changing spectrum needs and applications of fixed services.

Industry Canada recognizes that a diversity of microwave radio facilities in terms of capacities and applications will continue to play a key role in the development of a world-class information infrastructure. Also, the microwave spectrum requirements have to be carefully balanced against the demands of a wide range of radio services and systems.

Copies of the subject documents of this Notice are available from the Communications Branch, Industry Canada, 235 Queen Street, Ottawa, Ontario K1A 0H5, (telephone: (613) 947-7466) or from its offices in Moncton, Montréal, Toronto, Winnipeg and Vancouver.

The document is also available electronically on the Internet addresses:

Anonymous File Transfer (FTP)

[debra.dgbt.doc.ca/pub/isc/gazette](ftp://debra.dgbt.doc.ca/pub/isc/gazette)

Gopher

[debra.dgbt.doc.ca port 70/Industry Canada Documents](gopher://debra.dgbt.doc.ca:70/Industry%20Canada%20Documents)

World Wide Web (WWW)

<http://debra.dgbt.doc.ca/isc/gazette>

Dated at Ottawa, this 12th of January, 1995.

Michael Helm
Director General
Telecommunications Policy Branch

Part A

1. Background

1.1 Introduction

In the Spring of 1993, Industry Canada initiated a comprehensive Spectrum Policy Review to take advantage of the new frequency allocations made by the 1992 World Administrative Radio Conference (WARC-92) and supported by Canada. Moreover, the Review was aimed at accommodating the increasing spectrum demand by new and emerging radio services and providing the basis for the modernization of the spectrum policies for fixed services, given the changing nature of microwave system applications. Five spectrum policy proposal papers, each covering a different part of the Canadian Table of Frequency Allocations and a range of utilization policies for certain services and radio bands, were released to begin a wide public consultation.

In Gazette Notice DGTP-005-93, dated May 28, 1993, Industry Canada released the document *Proposed Spectrum Utilization for Certain Services Above 1 GHz*, requesting public comment by 1 November 1993. An *Addenda*, dated October 7, 1993, granted an extension to the comment period until 10 January 1994 for a portion of the spectrum under review, specifically, the frequency range 1700-2290 MHz. The other four documents dealt mainly with changes to the allocations table in the frequency ranges 3-30 MHz, 30-960 MHz, 1-3 GHz and above 3 GHz, respectively.

Based on the extensive public comments received and findings from public meetings organized by the industry, Industry Canada has issued Revisions to the Canadian Table of Frequency Allocations to take advantage of the new International allocations which are responsive to the particular Canadian needs. Now, Industry Canada is issuing under this document a comprehensive series of spectrum utilization policies for fixed service and provisions to accommodate new radio services.

1.2 Spectrum Allocation

The result of the division or allocation of the radio frequency spectrum in Canada is published in the Canadian Table of Frequency Allocations. The simplicity of the display in the Table (that a certain frequency band is available for a certain radiocommunication service) belies the complexity of its derivation. Factors such as how much spectrum is required for a given purpose, where it is located (both in frequency and geographically), what other services must share the band and, at what date does a band change from an old use to a new, must be resolved. The more popular frequency bands have been in use for many years and there are many new demands emerging every year. Changes often cause challenges for both existing and new services to ensure the radio spectrum continues to meet evolving technology and service requirements.

The Canadian Table is derived from the treaty arrangement that governs the International Telecommunications Union (ITU). The ITU Table of Frequency Allocations reflects the consensus of a very wide diversity of interests around the world. It, too, is the culmination of a large number of sometimes difficult domestic, foreign and international decisions. The new

Canadian Table is the basic spectrum policy instrument where frequency bands are allocated to a number of radio services. (For example, the document entitled Revisions to the Canadian Table of Frequency Allocations (1994), issued October 29, 1994 in the Gazette Notice DGTP-005-94 provides for the adoption of the decisions of WARC-92 and changing spectrum requirements in Canada).

The recent ITU reorganization has resulted in, among other things, conferences being held every two years. A World Radiocommunication Conference has been scheduled for 1995 (WRC-95) which will review some of the decisions of WARC-92 on mobile satellite service. Future spectrum policy activity will be required to respond to WRCs and changing demands on the spectrum in Canada. The introduction of new services such as digital radio broadcasting, personal communications, advanced mobile satellite networks, and the promise of other new services arising from 'digital convergence' is part of the ongoing reviews. In this era of change, one major objective of spectrum policy is to provide flexibility and stability for spectrum users. Where uncertainty is perceived, the provisions of the policies attempt to identify the possible change and when it may take place. In some cases restrictions or advisories may be included to manage the future use of a band.

1.3 Spectrum Utilization

Consequential to the inter-service spectrum allocation issues previously discussed which are contained in the Canadian Table of Frequency Allocations, the intra-service conditions of use of a band by a service are often specified in a Spectrum Utilization Policy (SP). The intra-service goal of a spectrum utilization policy is to match and balance the different types of demand within a service category over the many bands available to meet Canadian needs. These needs can differ significantly from those of Europe, Japan, the U.S., or other countries because of geography, economics, regulatory environments, social values, civil and military priorities, manufacturing opportunities and other aspects of our nation's unique characteristics.

Among the most industrialized countries, some of the spectrum needs in Canada are quite distinct. In our highly populated areas, there is a good match of spectrum requirements with our economic peers, but the great distances between our population centres have fostered the use of significant amounts of spectrum to provide high quality and low cost inter-city communication facilities. In more remote regions, the use of cost effective radio systems has led to the provision of telecommunication service to many Canadians. Appropriate domestic policies can optimize spectrum use for the different geographical situations to match domestic radiocommunication demands in support of a more efficient telecommunications infrastructure. Advantage can be taken of the geographical differences when policies provide an incentive for spectrum users to employ different system designs and for Canadian manufacturers to design equipment that can be used and sold in both developed and developing countries.

In some countries, utilization policy is founded on the type of users. For example, a designated band, sometimes called a "block allocation," is assigned to government or non-government users, common carriers or private carriers. In Canada, more emphasis is placed on type of use, eg. the bands are differentiated by their radio system applications, traffic type or systems capacity. This permits a band to be shared by many different users but optimized for a certain usage. There are several advantages to this, such as broadening the market base for the type of equipment used in a band. It also provides a user with a wider choice of bands, resulting in

more evenly distributed spectrum occupancy. The new policies which follow continue to extend the principle of "type of use" over a number of fixed service bands.

1.4 Technical Standards and Licensing Aspects

The International Table of Frequency Allocations provides the base for the Canadian Table, which in turn is the base for Spectrum Utilization Policies. Further steps are required to implement radio services. These include the development of technical standards, usually in the form of a Standard Radio System Plan (SRSP) for a band and service, and the availability of radio licensing policies and procedures. It has been the practice of Industry Canada to carry out much of the work in parallel for the development of policies and standards to minimize the delay from policy inception to system implementation. This requires working quickly, liaising closely with industry, forward planning and maintaining vigilant contact with international spectrum related developments.

2. Policy Development Considerations

2.1 The Fixed Service

Historically, the fixed service or microwave radio service has been the largest user of spectrum above 1 GHz; therefore most of the utilization policies issued for the spectrum above 1 GHz deal with this service. The objectives of spectrum policies have been generally to provide suitable spectrum for a variety of fixed service system applications, such as:

- long-haul, heavy route microwave systems used predominantly by common carriers;
- light-to-medium route microwave systems used by common carriers, utility companies, government agencies, and more recently, cellular and private companies;
- systems supporting broadcast-undertakings which include short studio-transmitter links, highly portable news gathering units, inter-studio video transmission, and a variety of point-to-point and multipoint systems for CATV operations.

In the future, additional spectrum is needed to support fixed service for such applications as:

- new long distance common carriers which may initially have modest traffic demands;
- microwave systems to provide broadband wireless access to the information highway;
- new inter and intra-city private systems;
- microwave facilities to interconnect local personal communication networks or cells;
- new microwave radio applications emerging from digital transmission techniques.

Revisions to spectrum utilization policies should respond to fundamental change in transmission technology such as the growing use of fibre optic facilities in the telecommunication

infrastructure. The future growth rate of spectrum use by heavy route systems should generally reduce and eventually decline as fibre networks become fully developed by the turn of the century. An exception may be in areas where the terrain provides severe hardship for the installation/maintenance of fibre optic cable systems.

Other services using or planning to use fixed service spectrum will need to be accommodated, for example:

- the fixed-satellite service, which shares many fixed service bands, should not be unduly disadvantaged by changing policies;
- digital radio broadcasting;
- mobile-satellite;
- personal communications and other emerging mobile applications.

To maintain viable microwave radio systems while introducing new radio services requires a re-balancing of the fixed bands for the different types of traffic capacities in a manner that encourages early change while minimizing the economic penalties. At the same time, spectrum for the new services must become available in reasonable timeframes. New re-arranged bands should be as stable as possible from significant changes for the foreseeable future. Generally, spectrum use by the microwave fixed service should evolve with changing technology and service requirements. Considerations as described below should be given particular attention:

- Encourage the use of higher frequency bands for short hops and the preservation of lower frequency bands for long hops;
- Maintain the core bands at 4 GHz and 6 GHz for high capacity and longhaul systems. As mentioned above, the existing heavy-route microwave radio systems will generally decrease as more traffic is transferred to fibre optic systems. However, new heavy-route entrants will likely use these bands and in the longer term, new demands for wideband transmission may arise from digital convergence. For the foreseeable future, the preservation of these bands for higher capacities is appropriate, provided lower capacity systems have adequate access to other bands in the 1-10 GHz range;
- Encourage licensing of new microwave systems in bands that have the greatest potential for long term stability - often those bands which share easily or uniquely with other services;
- Avoid significant changes to systems or standards in bands that may be likely candidates for future re-allocation;
- Provide adequate spectrum for an increasing near-term demand for low and medium capacity systems which may result from new microwave licensing policies fostering the entry of new microwave spectrum users;
- Provide for the potential increase in demand for the ancillary use of fixed spectrum for emerging broadcast services such as advanced TV and digital radio;

- Achieve an increase in the efficient use of the spectrum to accommodate the effect of future reductions of the spectrum available to the fixed service;
- Support equipment designed and manufactured to meet Canadian needs;
- Permit more flexible and economic use of the radio spectrum, by relaxing policies and technical standards in geographical areas of very low spectrum usage, and by tightening them in areas of frequency congestion;
- Support effective band sharing arrangements of fixed service with other radio services such as the fixed-satellite service.

Part B

Revisions to the Microwave Spectrum Utilization Policies in the Range of 1-20 GHz

1. Policy Conclusions

1.1 Background

As a result of the comprehensive Spectrum Policy Review undertaken in the spring of 1993 to take advantage of the new frequency allocations made by WARC-92, Industry Canada announced in October 1994, in Gazette Notice DGTP-005-94 a series of revisions to the Canadian Table of Frequency Allocations. Several new allocations were made in the 1-3 GHz range which have significant impact on existing microwave spectrum policies. *The Proposed Spectrum Utilization for Certain Services Above 1 GHz*, issued in May 1993, under Gazette Notice DGTP-005-93, provided the basis to carry out the widest public consultation on the necessary revisions to the microwave spectrum utilization policies. This document also covered many frequency bands above 3 GHz to address the need to accommodate new growth of microwave radio systems.

Thirty-one public responses were received providing extensive insight into future policy directions, some of which were fairly diverse in their conclusions. Based on the extensive public comments received and the findings from industry meetings, Industry Canada is now in a position to issue revisions to the existing fixed service microwave spectrum policies which will meet the spectrum requirements of Canada. To the extent possible the new spectrum policies address and satisfy most of the identified spectrum needs.

1.2 Relationship Between Spectrum Allocation and Utilization Policies

The general spectrum policy principles document referred to as *General Information Related to Spectrum Utilization and Radio Systems Policies* (SP-GEN), will be revised to include several new principles outlined in Section 1.0. This will include, among other aspects, the following provisions:

The allocation principles of "primary" and "secondary" define the priority between two radiocommunication services (such as the fixed service and the mobile service) which share the same band. The spectrum utilization principles of "standard" and "non-standard" status apply solely to systems within the same radio service, and are based on compliance with Spectrum Utilization Policies (SPs) and Standard Radio System Plans (SRSPs). The relative spectrum status between any two radio services is determined in the Canadian Table of Frequency Allocations and the accompanying footnotes, while relationships within a service are prescribed by the relevant SPs and SRSPs.

Thus a "primary service" system that does not meet all of the conditions established within that service by an SP or SRSP is not considered to have a lower status than a system in another primary service. A non-standard system in one "primary service" will not have a lower status compared to a system in another primary service. The other service may not even have a specific spectrum policy or standard that must be met.

Primary/secondary and standard/non-standard designations can both distinctly and separately apply to a given assignment.

This distinction will be added to SP-GEN along with the existing definitions of standard and non-standard and the terms and conditions of the 5 and 2 year rule for non-standard systems.

1.3 Re-accommodation of Existing Fixed Systems and the Introduction of New Personal Communications Services and Terrestrial Digital Radio Broadcasting

The Spectrum Policy Framework for Canada issued in 1992 outlines, among other things, the policy guidelines dealing with the allocation of spectrum resources and the displacement of radio systems. The Policy Framework states that the frequency spectrum is a public resource which needs to be allocated and planned to advance public policy objectives, and that access to the spectrum would be adapted to meet the changing user requirements and facilitate new and innovative services. Industry Canada's policy remains that a radio licence does not confer ownership or continued right to a particular radio frequency, and that reasonable notice is to be given to users of any conditions or circumstances which could result in the displacement of their services or systems to other bands. Moreover, there is no liability or responsibility or intent by Industry Canada to financially compensate spectrum users being displaced.

In the 1-3 GHz range, most of the bands recently re-allocated are already in use by the fixed service. As discussed in DGTP-005-93, the 5 and 2 year rule for the removal or upgrade of a non-standard existing system to permit the entry of a new system in the **same** service is not appropriate to enable the changes required to permit the use of a frequency band by **another** service.

1.3.1 Terrestrial Digital Radio Broadcasting

The revised Canadian Table of Frequency Allocations (Revisions to the Canadian Table of Frequency Allocations (1994)) has allocated the frequency band 1452-1492 MHz for Digital Radio Broadcasting (DRB). Canadian footnotes C29 and C30 supporting the new allocation indicate that existing fixed stations may continue to use the band provided that they do not cause interference to, or claim protection from, stations operating in the broadcasting service which are to be implemented according to a domestic allotment plan. Furthermore, it indicates that as the domestic allotment plan is developed it will take into account stations in the fixed service, to the extent possible.

It is anticipated that a broadcasting allotment plan will be adopted by Industry Canada by the end of 1995. The DRB allotment plan will stipulate the DRB channel blocks to be assigned in various geographical areas of the country for terrestrial broadcasting. Industry Canada will identify the DRB channels blocks that may impact on existing fixed stations as the broadcasting service is gradually implemented.

As the planning and licensing process for particular digital radio broadcasting stations begin or the planning for such broadcasting stations becomes known, the incompatible fixed stations will be identified and notified as early as possible. During the two year period after the allotment plan has been formally adopted, fixed service licensees would be given a minimum of a two year notification by Industry Canada for displacement of specific installations in order to

accommodate the implementation of DRB stations. After the two year period following the adoption of a DRB allotment plan has elapsed, the minimum notification period will be one year.

Fixed service operators are expected to take advantage of opportunities, such as transmission equipment replacement, to re-engineer their systems to cease using identified potentially impacted frequencies in the 1452-1492 MHz band, even if a displacement notification has not been issued. Also, broadcasters are expected to take advantage of available alternate channel blocks to permit the continued operation of near-by fixed stations.

1.3.2 New Personal Communications Services

In the public submissions received from Gazette Notice DGTP-005-93, there was strong public support and interest for the designation of spectrum for a new family of personal communications services (PCS) near 2 GHz. Also, the public comments supported the development of a transitional mechanism to take into account the existing microwave facilities that were being displaced and to vacate an appropriate amount of spectrum for the introduction and development of PCS services. Accordingly, as indicated in the policy proposal paper dealing with PCS at 2 GHz (DGTP-006-94) issued November 5, 1994, Industry Canada proposes to proceed with the accommodation of spectrum resources relating to existing microwave systems and the new PCS, as follows:

- i) The *Revisions to the Canadian Table of Frequency Allocations (1994)* issued on October 29, 1994 (Gazette Notice DGTP-005-94) has established the general range of spectrum that may be designated for PCS service. Canadian footnote C35¹ in the Table indicates the earliest dates that some of the fixed radio systems may be impacted by PCS in certain sub-bands and geographical areas. The timing of the implementation of the PCS will become known as the licensing process progresses. The allocation has served as a **general notification to existing microwave users of potential displacement**.
- ii) Further, a series of *Microwave Spectrum Utilization Policies* is being issued in this policy document to, in part, re-arrange fixed radio bands at 2 GHz and permit the establishment of spectrum policies to accommodate new services, including PCS. Industry Canada strongly encourages existing microwave users to take advantage of the availability of frequencies in the modified fixed bands, on a first-come, first-served basis, so as to economically modify their equipment outside the general spectrum range designated for PCS as indicated in the Canadian Table (1850-1990 Mhz).
- iii) A *PCS Policy Framework* will be developed from the comments received in response to the Gazette Notice (DGTP-006-94) dealing with issues such as service aspects, the band limits and the specific blocks of spectrum to be designated, and the provisions of a Spectrum Transition Policy regarding the displacement of fixed stations to make frequency spectrum available, where necessary for PCS systems. A large number of existing 2 GHz users can be

1 C35 (CAN-94) Existing fixed stations operating in the band 1850-1990 MHz will have priority over the mobile service until 1 July 1997. After this date, specific fixed stations will need to be displaced where necessary to enable the implementation of new mobile systems such as personal communications. The displacement of fixed stations as well as the implementation of new mobile systems will be governed by spectrum utilization policies.

re-accommodated in other parts of the non-affected 2 GHz bands. Also, it is recognized that operators may choose to re-build their systems at higher frequency bands or use other communication media such as fibre optic facilities.

- iv) DGTP-006-94 indicated that effective November 5, 1994 there is a moratorium on licensing of new fixed microwave applications in the 1850-1990 MHz band.

1.4 Industrial, Scientific and Medical (ISM) Devices

Interference can occur to fixed systems from certain unlicensed devices in the ISM bands. Since these devices will increase in number with time, Industry Canada will not encourage licensing of systems in ISM bands, particularly in highly populated areas, unless future developments reduce this problem. On this basis, there are no spectrum utilization policies proposed for the ISM bands of concern, namely 2400-2500 MHz and 5725-5875 MHz.

1.5 Very Low Capacity (VLC) Fixed Systems

General arrangements are not required for Very Low Capacity systems (VLC: less than 1 DS-1), but they may be accommodated on a band-by-band basis. Generally, VLC systems will be discouraged in Medium and High Capacity (MC and HC) bands to avoid blockage of MC and HC systems by narrow band VLC systems.

1.6 Geographical Differences Policy Guideline

In order to recognize the need for flexibility in spectrum utilization policies and technical standards, Industry Canada will introduce a guideline which will permit enhanced provisions in congested areas and some relaxation of policy and/or technical requirements in uncongested areas. The Geographic Differences Policy Guideline will allow service providers to economically redeploy older equipment in more remote areas. Conversely, in congested areas, service providers will have to meet enhanced policies and standards, such as improved antenna off-axis discrimination performance, to ensure the maximum number of systems can be accommodated. The following definitions of fixed service frequency congestion serve as general congestion level benchmarks upon which various utilization policies and technical standards apply:

Uncongested Area

An area in which the band has been available for use for a number of years but has had little or no use, nor is any projected. In terms of fixed service assignments, an indicator of an uncongested area is where 90% or more of the channels are available for use in 90% or more of the possible directions.

Normal Congestion Area

An area where the population of systems does not preclude the introduction of a significant number of new systems. An indicator may be where 50% to 90% of the channels are available in 90% or more of the possible directions.

Moderately Congested Area

An area in which the band is well used as intended, and there is adequate spectrum for future growth. A suitable indicator may be where 10% to 50% or fewer of the channels are available in 90% or more of the possible directions.

Highly Congested Area

An area in which the possibility of finding an assignment for a specific system application is low, or at least it is very difficult to make an assignment. In this case an indicator may be when 10% or fewer of the channels are available in 90% or more of the possible directions.

In general, the following policy provisions will govern the use of the radio spectrum by the fixed service in the defined congestion areas:

1. Uncongested Area Policy Provisions

In an uncongested area, which could be site specific, systems may be exempted from certain provisions of SPs and SRSPs. In such cases Industry Canada may consider these systems as compliant and award them the status of standard, subject to other conditions with SP-GEN and provided the system does not propose to use more than 30% of the spectrum in the band.

2. Normal Congestion Area Policy Provisions

Where the use of the spectrum exceeds the uncongested area limit, but has not reached the moderately congested level, the SP and SRSP criteria for a band would apply. Systems meeting these criteria would be standard.

3. Moderately Congested Area Policy Provisions

Where the moderately congested level is exceeded, but it is not yet highly congested, new applicants may be required to conform to SPs and SRSPs and the enhanced provisions normally applicable to highly congested areas, where there is an expectation of more demand for spectrum. Previously authorized systems which are in accordance with SP and SRSP criteria can remain on a "standard" basis.

4. Highly Congested Area Policy Provisions

In a location of highly congested spectrum, systems or components of systems not conforming to enhanced provisions of the SP and SRSP are non-standard and subject to the provisions of SP-GEN. Furthermore, systems which were originally licensed more than 15 years ago are subject to removal, modification or replacement within 2 years after a written notice from the Industry Canada.

5. Industry Canada reserves the right to ask applicants to make additional and/or alternative enhancements to their systems, if it is deemed in the public interest.

New spectrum utilization policies and technical standards may specify enhanced criteria to be applied in moderately and highly congested areas. It should be noted that this policy guideline

does not apply to other radio services nor does it affect the conditions of use of a band as given in the Canadian Table of Frequency Allocations, and that specific exemptions, differences or criteria may be contained in an SP or SRSP or determined at the point of licensing the system.

1.7 Reducing Types of Use

The transmission of broadcast-related signals can be carried in several fixed services bands where they meet the SP/SRSP criteria. Similarly, fixed bands normally used for broadcast signals networking can be used for other types of traffic, provided broader access in other microwave bands is available to broadcast-related applications. Any policy or standard to do this will be based on the feasibility to support the merging of traffic types in a given band.

Temporary TV-Links

This definition is not needed because of its similarity with TV Pick-ups, and will not appear in a revision of SP-GEN or in specific band policies. Such systems can use any band in which they meet policy and standards criteria.

Unidirectional Transmission

Many analogue video systems are one-way, so certain band SPs specifically address this requirement by exception, and consequently unidirectional transmission may be limited in certain bands. Unidirectional digital video systems shall, in general, have access to a large number of bands.

1.8 Path Lengths

There was a mixed public response on the proposals to require minimum path lengths. It is recommended that the criteria adopted by the FCC shown in Annex A be considered for incorporation in future SRSPs.

1.9 Fixed System Capacities

A spectrum policy for a band will specify the system capacity (e.g. Low Capacity, Medium Capacity), and if warranted, further specify limits on these capacities. Frequency channel efficiency and channel plans will be specified in SRSPs. The spectrum objectives for the overall carriage capacity of various microwave bands are stated in Section 1.12. The definitions of system capacities continue to evolve to reflect changes in transmission technology and microwave system requirements. The following definitions of system capacities will replace the existing definitions found in SP-GEN:

RF Channel Capacity	Traffic Load (Mbit/s)⁽³⁾	
Low Capacity (LC) ⁽¹⁾⁽²⁾	≥ 1.544	≤ 24.704
Medium Capacity (MC)	> 24.704	≤ 51.840
High Capacity (HC)	> 51.840	

- Notes (1) Smaller system capacities are also permitted in LC bands on a case-by-case basis.
- (2) Capacities of less than 1.544 Mbit/s are not permitted in channels identified for MC or HC, unless specifically identified in the spectrum policy for the band.
- (3) System capacities do not include radio system overhead bits.

Digital Signal (DS) levels and their relation in the digital transmission hierarchy are shown in the following table:

DS-0	64 kbit/s	1 voice ch. + signalling	
DS-1	1.544 Mbit/s	1 T1	24 DS-0
DS-2	6.312 Mbit/s	1 T2	96 DS-0
DS-3	44.736 Mbit/s	1 T3	672 DS-0
STS-1	51.84 Mbit/s	1 OC-1	672 DS-0
STM-1	155.52 Mbit/s	OC-32	2,016 DS-0
16 STM-1	2.48832 Gbit/s	OC-48	32,256 DS-0
32 STM-1	4.97664 Gbit/s	OC-96	64,512 DS-0

Notes: SONET is the North American technology used for STM-1

T1	24 circuits
T2	96 circuits
T3	672 circuits
OC-1	1 T3
OC-3	3 T3

Analog system capacities will be discontinued from the definitions of system capacities (SP-GEN), however, existing analog systems will remain standard with respect to the capacity definitions. Analog systems will be recognized in specific SPs where analog transmission is still required.

In bands where analog video systems are considered standard, new analog video systems will be required to use the band based on criteria established for digital systems, unless technical constraints suggest otherwise.

1.10 Non-Spectrum and Spectrum Alternatives

While Industry Canada will continue to encourage the use of non-spectrum transmission alternatives, spectrum especially for new high capacity microwave systems will be supported where it fosters the orderly and economic development of telecommunications. The following general policies will address the use of high capacity frequency bands vis-a-vis non-spectrum and spectrum attributes:

1. Industry Canada may choose not to authorize new high capacity radio systems or the expansion of existing radio systems when the applicant has adequate alternative facilities (such as fibre systems), including routing diversity.
2. Microwave networks that off-load traffic to other bands or fibre systems may cause an assignment to become non-standard because minimum RF channel capacity requirements are no longer met.
3. Networks that are primarily based in either the 4 GHz or the 6 GHz band are encouraged to consolidate their use in one of the bands.
4. Higher frequency bands or FOTS should be considered for entrance links from large systems to major metropolitan areas.

1.11 Frequency Diversity

The existing provisions of SP-GEN for frequency diversity will continue to apply, subject to band-by-band provisions of the Geographical Difference Policy Guideline.

1.12 Overall Carriage Capacity and Spectrum Efficiency

The total transmission capacity of fixed spectrum is determined by, among other things, the efficiency of use of the spectrum, measured in bits/second/Hertz (b/s/Hz). Although the capacity of a system may be dictated by a number of technical and economic factors, high carriage capacity cannot be achieved without high spectrum efficiency. High spectrum efficiency is a crucial objective for good spectrum utilization policy. As a result of the decisions of WARC-92 and the revisions to the Canadian Table, a considerable amount of fixed spectrum was re-allocated to new services in the 1-3 GHz range and more spectrum may be affected in the future. Also in the foreseeable future, the need for more microwave radio transmissions may very well increase as a result of more liberal microwave licensing policies and new digital radio applications. It is therefore in the best interests of the microwave spectrum users as a whole to obtain as much transmission capacity from the available spectrum. This will address several objectives:

- frequency bands will not fill as quickly, permitting growth for new and existing systems in the same band;
- more band choices will be available in the event that an allocation change to a band is required;
- efficiently used spectrum is less vulnerable to change.

Although a number of proposals addressing ways to designate the spectrum efficiency level within various frequency bands were presented in the discussion paper (DGTP-005-93), the responses did not indicate a preferred direction. Consequently Industry Canada will continue to study this issue and, as an interim measure, adopt the "Option 2" presented in

the discussion paper² which allows restrictions on the digital transmission rates of the current system capacities where congestion levels or other conditions warrant this measure. For example, a medium capacity band which is expected to be heavily used may be restricted to systems of DS-3 rates in moderate to highly congested areas, as defined by the Geographical Difference Policy. Furthermore, in order to balance the spectrum use, limits on available channel bandwidth and possible partitioning of bands to accommodate various LC, MC and HC systems may be introduced in various SPs or through provisions of the Geographical Differences Policy.

With the reduction of the amount of spectrum available for microwave fixed systems below 10 GHz, it is imperative that SRSPs be developed to foster highly spectrum efficient systems.

2. Spectrum Utilization Policies for Certain Frequency Bands

This section contains the new revised microwave spectrum utilization policies. The spectrum policy provisions deal primarily with, but not limited to, the fixed service. A full description of the relationship between bands and services, as contained in related international and domestic footnotes, can be found in the Canadian Table of Frequency Allocations (1991 edition) and in the Revisions to the Canadian Table of Frequency Allocations (1994).

Each frequency band has a descriptive bar chart showing the division of spectrum between the various radio services. This is followed by detailed policy provisions. In the bar charts, a service written in capital letters is a primary service, and one written in both upper and lower case is a secondary service. This document addresses the **major** revisions to the spectrum utilization policies. There were many policy provisions in SP-GEN and a limited number of policy provisions in various SPs that were not proposed for revision during the consultation process. **In general, these provisions are in effect and will be included in future consolidation of the policy documents.**

Additional spectrum utilization policies that may apply to more than one of the following bands are contained in the SP-GEN publication. Spectrum Policy (SP) documents will be revised according to the usage policies set forth in this document.

The domestic use of the fixed-satellite service, as identified in the *North American Trilateral Agreement* and in Appendix 30B of the *ITU Radio Regulations*, is contained in *Radio System Policy RP-002 Policy for the Use of the Geostationary Satellite Orbit by Canadian Satellite Networks*.

2 "Option 2". Restrict the digital rates of the current system capacities where congestion levels or other conditions warrant this measure.

1350 - 1400 MHz

Service	1350	1370	1400
RADIOLOCATION			
AERONAUTICAL RADIONAVIGATION			
FIXED	Government of Canada		
MOBILE	Government of Canada		
Radio Astronomy			
Space Research (Passive) Earth Exploration- Satellite (Passive)			

1. A full description of the relationship between bands and services, as contained in related international and domestic footnotes, as well as the limitations on the use of the band 1350-1400 MHz by the fixed and mobile services, can be found in the Canadian Table of Frequency Allocations.

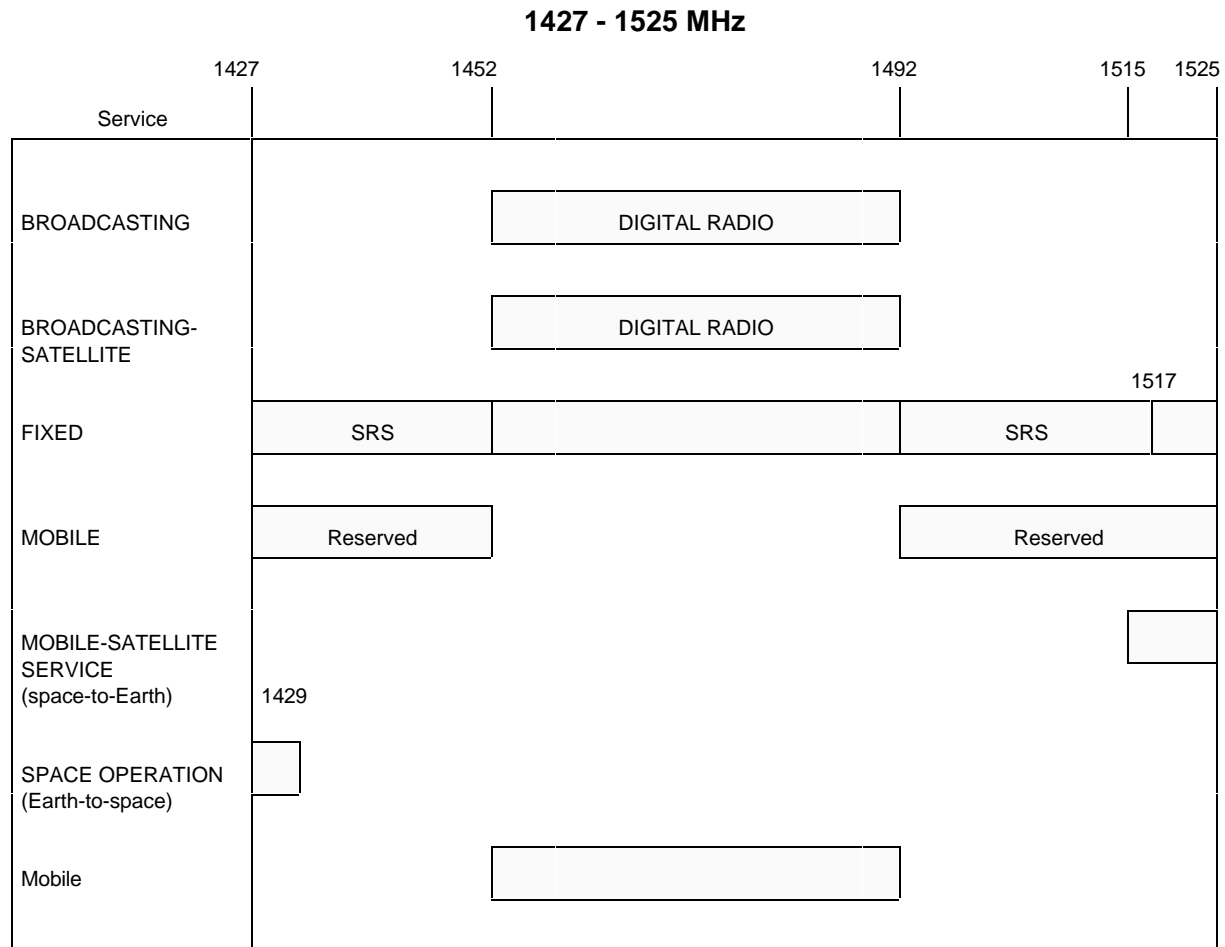

1. A full description of the relationship between bands and services, as contained in related international and domestic footnotes, including the relative status of the broadcasting/broadcasting-satellite and fixed, and of mobile-satellite and fixed services, can be found in the Canadian Table of Frequency Allocations.
2. Fixed Service Use: 1427-1452 MHz Subscriber Radio Systems (SRS)
 1492-1517 MHz Subscriber Radio Systems (SRS)
3. Existing fixed stations operating according to policies and standards in place in 1993 may continue to operate subject to criteria and procedures which may be established for the mobile-satellite service in the band 1515-1525 MHz and which will be established to implement digital radio broadcasting as part of the allotment plan in the band 1452-1492 MHz.
4. New Subscriber Radio Systems (SRS) shall be limited to the 1427-1452 MHz and 1492-1517 MHz bands. Where necessary, existing SRS may be re-tuned to these bands. The SRS use of this band shall start at the second highest frequency channel pair and work down in channel pairs in order to avoid potential conflicts with other services in adjacent bands. The highest frequency channel pair should be the last used noting that the 1515-1525 MHz band may be used by the mobile-satellite service.

5. New point-to-point fixed stations will not be permitted in the 1427-1525 MHz band. Existing point-to-point fixed stations are non-standard in this band with respect to SRS systems operating in the 1427-1452 MHz and 1492-1517 MHz bands.
6. The development of SRS stations may be limited by existing aeronautical mobile (telemetry) operations along the Canada/U.S. border.

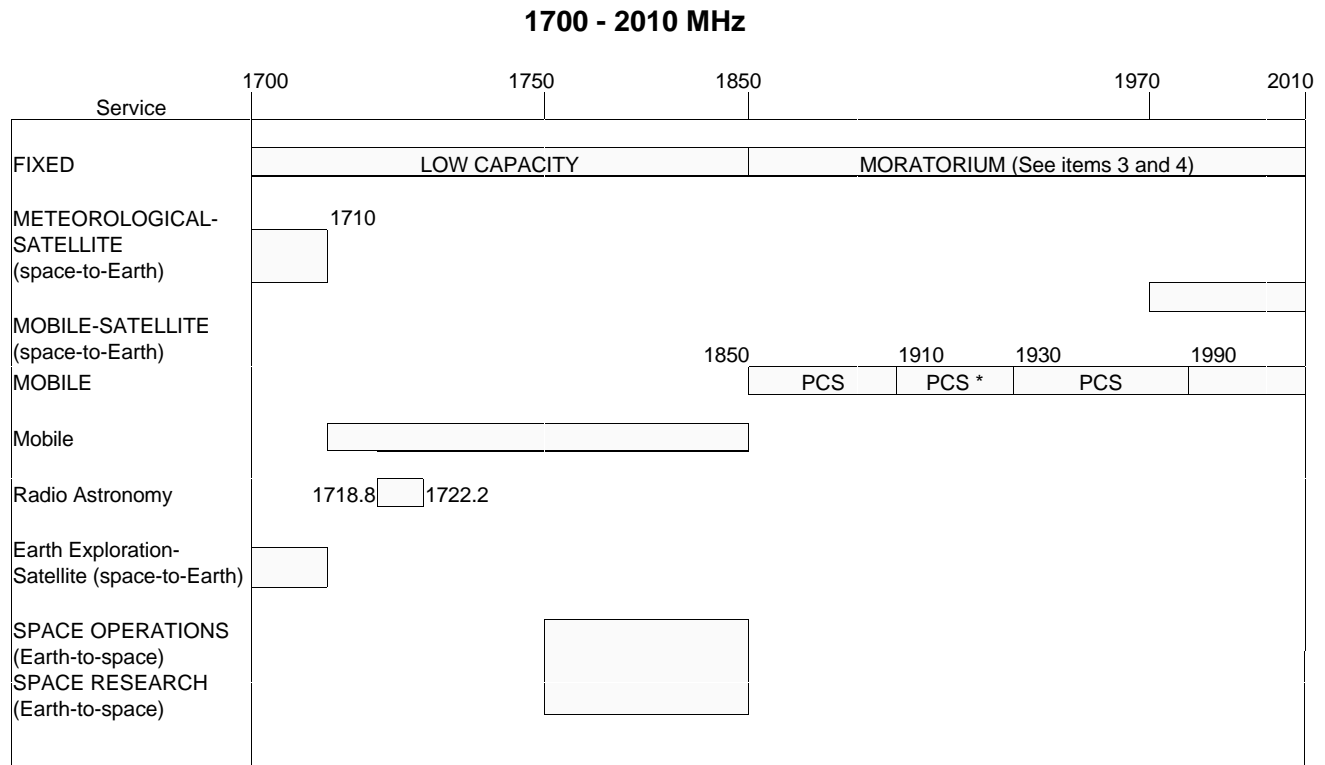

*license-exempt PCS

1. A full description of the relationship between bands and services, as contained in related international and domestic footnotes, can be found in the Canadian Table of Frequency Allocations. This includes the relative status of the fixed and mobile services near 2 GHz.
2. Fixed Service Use: 1700-1850 MHz Low Capacity Systems
3. In Gazette Notice DGTP-006-94, issued November 5, 1994, Industry Canada announced that effective immediately there is a moratorium on the licensing of new fixed microwave applications in the 1850-1990 MHz band.
4. Effective immediately, there is a moratorium on the licensing of new fixed microwave stations in the 1990-2010 MHz range due to future implementation of mobile satellite services. On a case by case basis modifications and/or extensions to existing systems may be permitted.
5. A spectrum transition policy will govern the displacement of existing fixed systems from sub-bands required for PCS in the 1850-1990 MHz band to other frequencies in the 2 GHz band or to other bands. The public consultations on the development of this transition policy is currently under way (DGTP-006-94). In general, fixed systems affected by PCS using the band 1850-1900 MHz may be transferred to the band 1700-1850 MHz, and fixed systems affected by PCS using the 1900-1990 MHz band may be transferred to the 2010-2110 MHz and 2200-2300 MHz bands. Early in the process, Industry Canada will normally give frequency assignment priority to fixed stations

which are to be transferred outside the 1850-1990 MHz band. In addition, higher priority of frequency assignment will generally be given to newer stations.

6. Existing analog systems which meet the requirements of SRSP 301.71 (Issue 3) are protected as standard systems, subject to the spectrum transition policy to accommodate PCS in the 1850-1990 MHz band. This would include analog systems that have been re-tuned as a result of the introduction of PCS stations in the 1850-1900 MHz band.
7. In moderately or highly congested areas the provisions of the Geographical Differences Policy Guideline which apply in the 1700-1850 MHz band are as follows:
 - i) any system cross-section shall not exceed 21 MHz in each direction;
 - ii) for systems requiring four frequency plans, any system cross-section shall not exceed 10.5 MHz in each direction.
8. In rural and remote uncongested areas, Subscriber Radio Systems may be authorized in the 1710-1850 MHz band under the Geographical Differences Policy Guideline.
9. Studio to Transmitter Links (STLs) for aural broadcasting using digital techniques will be considered as LC systems.
10. In the band 1700-1710 MHz, fixed stations may be required to coordinate with earth stations in the meteorological-satellite service.
11. The band 1700-1850 MHz may be subject to a future policy review to determine if the band is required for other uses after the year 2000.

2010 - 2300 MHz

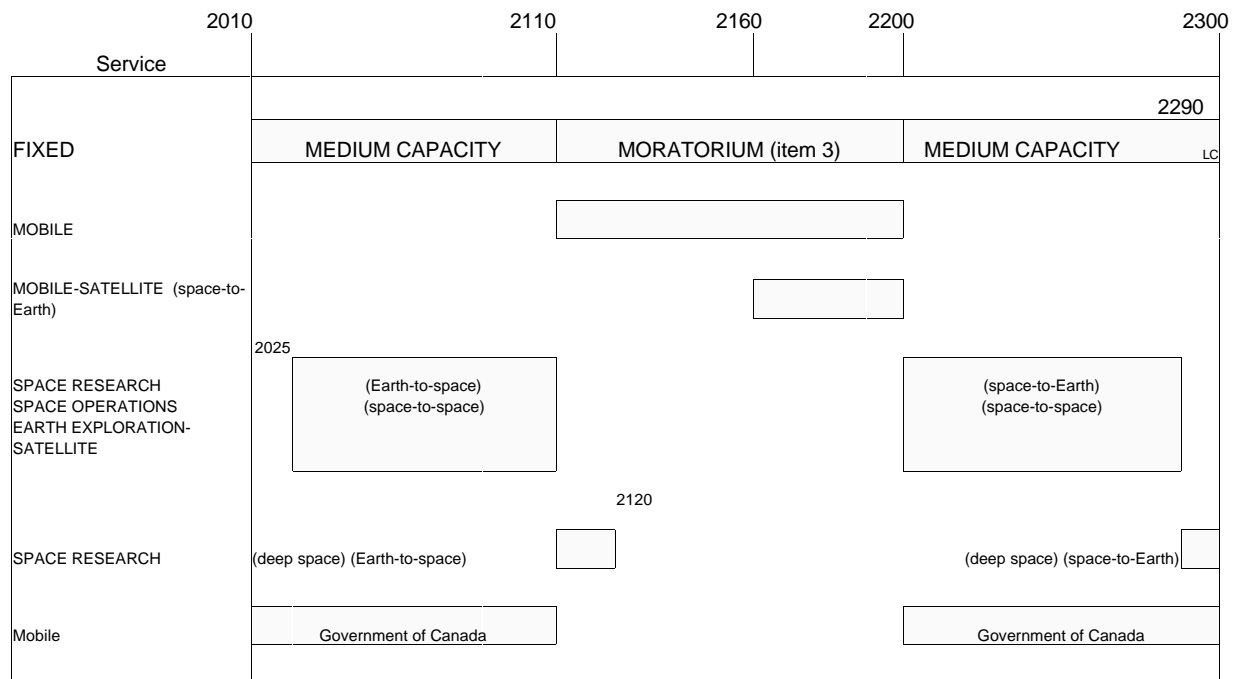

1. A full description of the relationship between bands and services, as contained in related international and domestic footnotes, can be found in the Canadian Table of Frequency Allocations. This includes the relative status of the fixed and mobile services near 2 GHz. Further public consultation will determine the implementation of additional radio services in the band 2110-2200 MHz such as PCS in the mobile service and mobile-satellite service.
2. Fixed System Use: 2010-2110 MHz Medium Capacity Systems
 2200-2300 MHz Medium Capacity Systems
3. Effective immediately, a moratorium exists on the licensing of new fixed microwave stations in the 2110-2200 MHz band. On a case-by-case basis modifications and/or extensions of existing systems may be permitted on a non standard basis.
4. No new systems using a 29 MHz wide RF channel will be authorized except under the provisions of the Geographical Differences Policy Guideline.
5. For new systems, the inequality in the number of go and return fixed service channels shall not exceed 25% of the total.
6. Existing fixed systems operating in the 1900-2290 MHz band but outside the 2010-2110 MHz and 2200-2300 MHz bands are protected as standard systems, subject to the spectrum transition policy to accommodate PCS in the 1850-1990 MHz band, if they comply with the SP and SRSP in effect in 1992. Any existing fixed system operating in the 2010-2110 MHz and 2200-2300 MHz bands will become non-standard and subject to

the provisions of the 2 year and 5 year rule of SP-GEN if they do not meet the requirements of the new SP and SRSP of these bands.

7. In moderately or highly congested areas the provisions of Geographical Differences Policy Guideline which apply in the 2010-2110 MHz and 2200-2300 MHz bands are as follows:
 - i) any fixed system cross-section shall not exceed 30 MHz in each direction;
 - ii) four frequency plans shall not be authorized.
8. In uncongested rural and remote areas Low Capacity systems or Subscriber Radio Systems may be authorized under the Geographical Differences Policy Guideline in the 2010-2110 MHz and 2200-2300 MHz bands.
9. In the band 2290-2300 MHz, existing fixed systems operating under SRSP 302.2, Issue 1 may continue to operate on a standard basis.

2300 - 2690 MHz

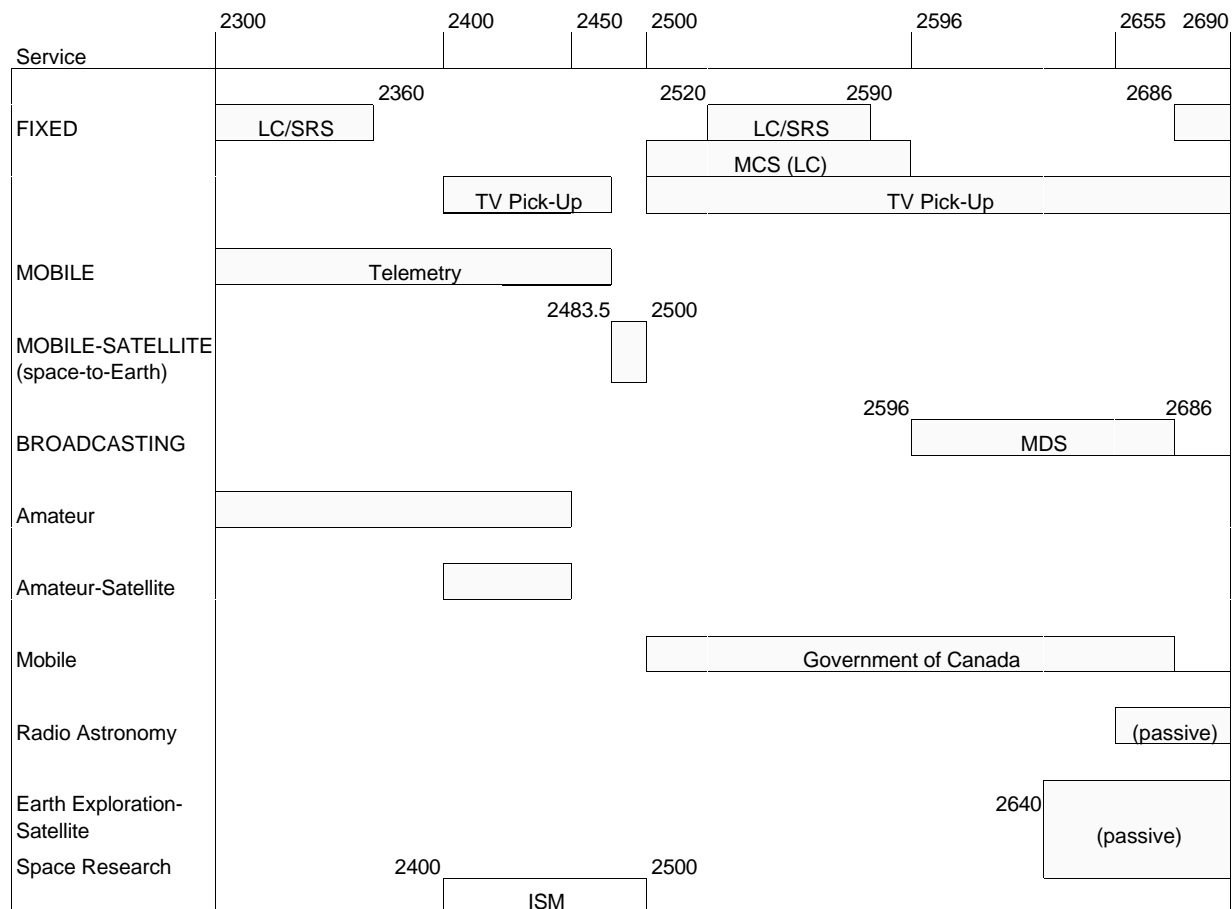

1. A full description of the relationship between bands and services, as contained in related international and domestic footnotes, can be found in the Canadian Table of Frequency Allocations.
2. Multipoint Communications Systems (MCS) to provide efficient bidirectional transmissions or broadband wireless access to subscribers for multi-media applications such as video (e.g. instructional TV, video conferencing), image, data, text may operate in the band 2500-2596 MHz on a standard basis.
3. Fixed Service Use:
 - 2290-2360 MHz Low Capacity Systems, SRS
 - 2520-2590 MHz Low Capacity Systems, SRS
 - 2500-2596 MHz MCS (Low Capacity)
 - 2400-2483.5 MHz TV Pick-ups
 - 2500-2690 MHz TV Pick-ups
 - 2596-2686 MHz Multipoint Distribution Systems (Broadcasting)

4. Use of the 2520-2590 MHz band for LC and SRS systems within 80 km of the Canada-U.S. border is subject to the coordination sharing arrangement between Canada and the United States.
5. In moderately or highly congested areas the provisions of the Geographical Differences Policy Guideline which apply in the 2290-2360 MHz and 2520-2590 MHz bands are as follows:
 - i) any new system cross-section shall not exceed 15 MHz in each direction, including protection channels;
 - ii) four frequency plans shall not be authorized.
6. The 2400-2483.5 MHz and 2500-2690 MHz bands may be used for TV Pick-ups on a temporary, per-event coordination (resulting in no unacceptable interference) basis. This use will not prevent the permanent assignment of frequencies to other standard systems except in areas where a consistently high demand for TV pick-up channels would warrant measures to ensure adequate spectrum is available for this type of application, as determined by the Regional Director General. The band 2520-2590 MHz may be used for TV pick-up only if suitable spectrum is not available in the 2400-2483.5 MHz, 2500-2520 MHz and 2590-2690 MHz bands.
7. Existing fixed systems which conform to the SRSP 302.2 (Issue 1) may continue to operate on a standard basis.
8. SRS may be limited to areas outside major metropolitan areas and are not permitted in the 2290-2300 MHz band except where specified in the spectrum utilization policies for the 2010-2300 MHz band.
9. The 2483.5-2500 MHz band is available for mobile-satellite systems subject to licensing and regulatory considerations and coordination procedures.
10. The mobile use of the bands 2300-2360 MHz and 2400-2483.5 MHz is limited to telemetry and is restricted to the Government of Canada. Mobile telemetry operations shall be coordinated with fixed service systems.
11. See SP 2500 MHz (Nov. 1991 edition) for spectrum policies regarding Multipoint Distribution Systems (MDS) in the band 2596-2686 MHz. As the bands 2500-2520 MHz and 2670-2690 MHz have been also allocated to mobile-satellite service (MSS) on an international basis, effective 2005, some public consultation may be necessary to make modifications to this spectrum, if MSS were to be implemented in Canada in these bands.
12. The band 2400-2500 MHz includes license-exempt low power radio devices, and industrial, scientific and medical radio frequency devices. Microwave ovens operate in this band and may be a source of interference in populated areas.

3500 - 4200 MHz

Service	3500	3700	4200
FIXED			
	MEDIUM / HIGH	HIGH CAPACITY	
FIXED-SATELLITE (space-to-Earth)	*		

* 3700-4200 MHz is paired with 5925-6425 MHz

1. A full description of the relationship between bands and services, as contained in related international and domestic footnotes, can be found in the Canadian Table of Frequency Allocations.
2. Fixed Service Use: 3500-4200 MHz High Capacity Systems,
3500-3700 MHz Medium Capacity Systems
(Subject to certain limitations in coastal areas)
3. In the band 3500-3700 MHz, Medium Capacity systems shall carry a minimum of 1 DS-3 per RF channel.
4. In the band 3500-4200 MHz, High Capacity systems shall carry a minimum of 2 DS-3 per RF channel.
5. New High Capacity systems in the band 3700-4200 MHz must justify a traffic growth to at least 9 DS-3. The inequality in the number of go and return channels shall not exceed 25% of the total number of go and return channels.
6. Any High Capacity system cross-section may use and begin growth in the band 3500-3700 MHz only when it is demonstrated that sufficient spectrum for forecasted growth is not available in the band 3700-4200 MHz.
7. No new analog frequency assignments; existing analog transmissions carrying video traffic may continue to operate until this traffic is converted to digital.
8. The band 3700-4200 MHz is shared with receiving earth stations in the fixed-satellite service, including a large number of license-exempt Television Receive Only (TVRO) stations.
9. Emissions from radars operating below 3500 MHz may cause interference in the lower parts of this band in some coastal areas.

		4400 - 5000 MHz								
Service		4400	4500	4545	4705	4800	4895	4950	5000	
FIXED		4460	4540		4735		4900	4990		
			GOC		HC		HC		GOC	
MOBILE		GOC (Government of Canada)								GOC
FIXED-SATELLITE (space-to-Earth)		*								
RADIO ASTRONOMY						4825	4835			
Radio Astronomy										
Space Research (passive)										
Earth Exploration- Satellite (passive)										

* 4500-4800 MHz is paired with 6725-7025 MHz

1. A full description of the relationship between bands and services, as contained in related international and domestic footnotes, can be found in the Canadian Table of Frequency Allocations.
2. Fixed Service Use: 4545-4705 MHz High Capacity Systems
4735-4895 MHz High Capacity Systems
3. In the 4545-4705 MHz and 4735-4895 MHz bands, High Capacity systems shall carry a minimum of 2 DS-3 per RF channel. These systems are not limited to branching and spur routes.
4. The fixed use of the spectrum range 4400-5000 MHz is limited to digital transmissions, except for the bands 4460-4540 MHz and 4900-4990 MHz.
5. Emissions from airborne radar altimeters operating below 4400 MHz may cause interference in the lower parts of this band.
6. The Geographical Differences Policy Guideline applies to fixed systems in 4545-4705 MHz and 4735-4895 MHz bands.
7. Fixed service use of the 4540-4900 MHz band is subject to the Canada/U.S. sharing arrangement contained in SP 4400, Annex 2.

5850 - 6425 MHz	
Service	5850 5915 6425
FIXED	LC/MC HIGH CAPACITY
FIXED-SATELLITE (Earth-to-space)	*
Amateur	5925
Radiolocation	5875
(ISM)	

*3700-4200 MHz is paired with 5925-6425 MHz

1. A full description of the relationship between bands and services, as contained in related international and domestic footnotes, can be found in the Canadian Table of Frequency Allocations.
2. Fixed Service Use: 5850-5915 MHz Low and Medium Capacity Systems
5915-6425 MHz High Capacity
3. In the band 5915-6425 MHz, High Capacity systems shall carry a minimum of 2 DS-3 per RF channel.
4. New High Capacity systems in the 5915-6425 MHz band must justify a growth to at least 9 DS-3. The inequality in the number of go and return channels shall not exceed 25% of the total number of go and return channels.
5. High Capacity systems which are expansions of systems in 5915-6425 MHz may use 6425-6930 MHz under the conditions established for the band 5915-6425 MHz, provided channels are not available in the 5915-6425 MHz band.
6. Any High Capacity system cross-section using the 5915-6425 MHz band may use and begin growth in the band 6425-6930 MHz after it is determined that additional growth in the 5915-6425 MHz band is not possible.
7. No new analog frequency assignments; existing analog channels now carrying video may continue to operate only until the existing video traffic is converted to digital.
8. In the 5850-5915 MHz band, High Capacity fixed systems will be permitted on a case-by-case basis where additional channels are required to facilitate overbuilds of systems operating in the 5915-6425 MHz band.

6425 - 7125 MHz

Service	6425	6930	7075	7125
FIXED	MEDIUM/HIGH CAPACITY, STL		TV Pick-ups	
	FIXED-SATELLITE (Earth-to-space) *			

* 6725-7025 MHz is paired with 4500-4800 MHz

1. A full description of the relationship between bands and services, as contained in related international and domestic footnotes, can be found in the Canadian Table of Frequency Allocations.
2. Fixed Service Use: 6425-6930 MHz Medium and High Capacity Systems, Studio-Transmitter Links (STL)
6930-7125 MHz TV Pick-ups
3. The band 6425-6930 MHz may also be used for video STLs, which are limited to a maximum of 4 channel-hops. It is anticipated that video STL applications will evolve to digital technology, consequently, these systems may use the point-to-point system channels as per any digital fixed system.
4. High Capacity systems which are expansions of systems in 5915-6425 MHz band may use 6425-6930 MHz under the conditions established for the band 5915-6425 MHz, provided channels are not available in the 5915-6425 MHz band.
5. New High Capacity systems which require growth of 9 DS-3 or more shall use the 6425-6930 MHz band only where channels are not available in the 5915-6425 MHz band to meet the traffic requirements of the system.
6. In the band 6425-6930 MHz, High Capacity systems requiring 2 or more traffic channels shall use the lowest available frequency channel pairs, while systems requiring a single traffic channel shall use the highest available channel pair.
7. In general, pre-allotted frequencies for TV-Pick-ups will no longer be identified in the band 6930-7125 MHz.
8. TV-Pick-ups are limited to an EIRP of 47 dBW.

"Revision, Issued January 18, 1997
Gazette Notice DGTP-001-97/SME-001-97"

7125 - 7725 MHz

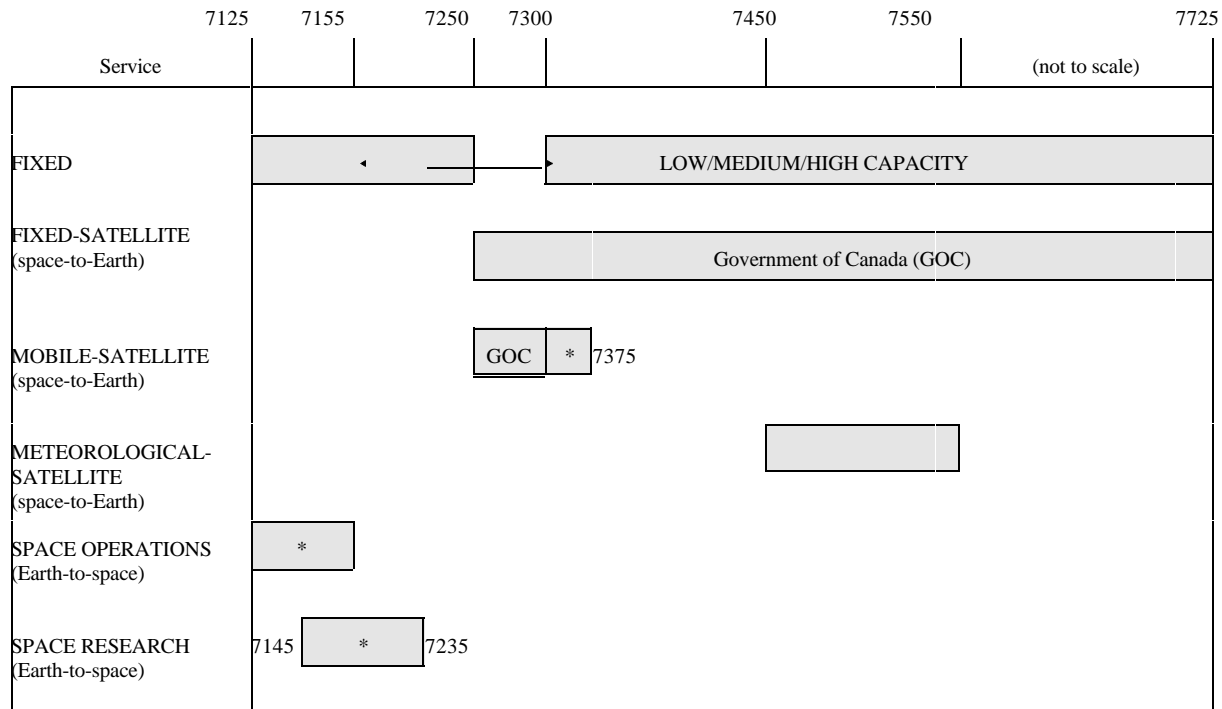

***Article 14, ITU Radio Regulations**

1. A full description of the relationship between bands and services, as contained in related international and domestic footnotes, can be found in the Canadian Table of Frequency Allocations.
2. Fixed Service Use: 7125-7250 MHz Low, Medium and High Capacity Systems
7300-7725 MHz Low, Medium and High Capacity Systems
3. Fixed service assignments in this band may accommodate a variety of point-to-point fixed systems including systems carrying critical telemetry, control and protection circuits, to support power distribution grids of the electrical utilities.
4. Existing systems which comply to SRSP 307.1 (Issue 3) may continue to operate as standard until January 1, 1999. After this date these systems will be subject to the 2/5 year rule contained in the SP-Gen.
5. Two 30 MHz channel pairs will be identified in the Standard Radio System Plan (SRSP) for the exclusive use by electric utilities. Other channelling arrangements may overlap the two 30 MHz channel pairs, however, the overlapping channels should only be used where other channels are not available.

"Revision, Issued January 18, 1997
Gazette Notice DGTP-001-97/SME-001-97"

6. In moderately and highly congested areas the provisions of the Geographical Differences Policy guideline which apply in the 7125-7725 MHz band are as follows:
 - four frequency plans or frequency diversity will not be permitted except, on a case-by-case basis, where the system(s) is providing critical telemetry, control and protection circuits for the electric power distribution grid.
7. Low Capacity systems may carry less than 1 DS-1 per RF channel.

		7725 - 8275 MHz							
		7725	7900	7975	8025	8175	8215	8275	
Service									
FIXED		MEDIUM/HIGH CAPACITY				MEDIUM/HIGH CAPACITY			
FIXED-SATELLITE	7750 (GOC)	Government of Canada (GOC)							
MOBILE-SATELLITE (Earth-to-space)		*		GOC					
EARTH EXPLORATION-SATELLITE (space-to-Earth)									
METEOROLOGICAL SATELLITE (Earth-to-space)								□	

***Article 14, ITU Radio Regulations**

1. A full description of the relationship between bands and services, as contained in related international and domestic footnotes, can be found in the Canadian Table of Frequency Allocations.
2. Fixed Service Use: 7725-7975 MHz Medium and High Capacity Systems
8025-8275 MHz Medium and High Capacity Systems

8275 - 8500 MHz

Service	8275	8400	8500
FIXED	LOW/MEDIUM CAPACITY (VIDEO)		
FIXED-SATELLITE (Earth-to-space)	Government of Canada		
EARTH EXPLORATION SATELLITE (space-to-Earth)			
SPACE RESEARCH (space-to-Earth)			

1. A full description of the relationship between bands and services, as contained in related international and domestic footnotes, can be found in the Canadian Table of Frequency Allocations.
2. Fixed Service Use: 8275-8500 MHz Low Capacity (Video) Systems,
Medium Capacity (Video) Systems
3. Existing analogue systems may continue to operate and expand.
4. Single hop systems are permitted on a case-by-case basis taking into consideration the spectrum requirements of the multihop video systems.

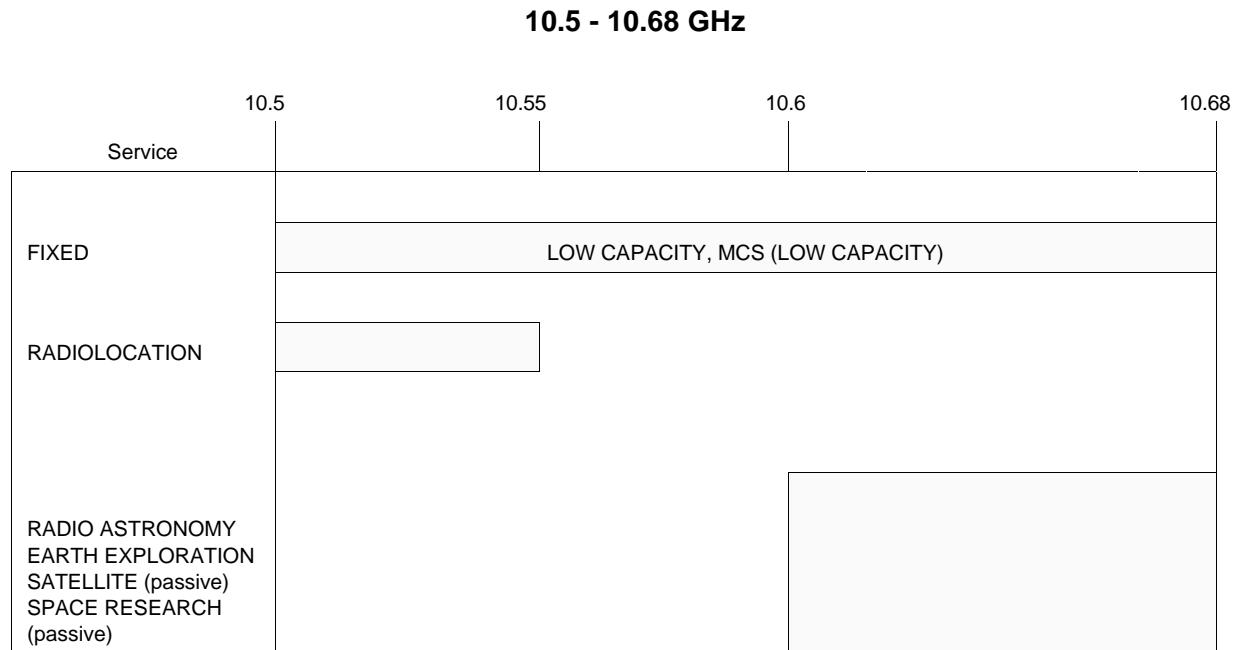

1. A full description of the relationship between bands and services, as contained in related international and domestic footnotes, can be found in the Canadian Table of Frequency Allocations.
2. Fixed Service Use: 10.5-10.68 GHz Low Capacity Systems, MCS (Low Capacity)
3. System capacities less than the DS-1 rate are permitted.
4. There is possible interference from low power devices for speed measuring operating at 10.525 GHz.

10.7 - 11.7 GHz

Service	10.7	10.95	11.2	11.45	11.7
FIXED	MEDIUM/HIGH CAPACITY				
FIXED-SATELLITE (space-to-Earth)	*				

* 10.7-10.95/11.2-11.45 GHz are paired with 12.75-13.25 GHz;
and 11.45-11.7 GHz is paired with 13.75-14.0 GHz.

1. A full description of the relationship between bands and services, as contained in related international and domestic footnotes, can be found in the Canadian Table of Frequency Allocations.
2. Fixed Service Use: 10.7-11.7 GHz Medium and High Capacity Systems
3. Low Capacity systems may have access to the spectrum in the 10.95-11.45 GHz band. This access is limited to a maximum of 80 MHz, 40 MHz in each direction.
4. The band 10.7-10.95 GHz may be used for feeder links (space-to-Earth) from mobile-satellite space stations within specific sub-bands.
5. No new analog systems will be permitted.

12.7 - 13.25 GHz

Service	12.7	12.75	13.0	13.15	13.2	13.25
FIXED	VHCM, TV STL, TV Pick-up					
FIXED-SATELLITE (Earth-to-space)	*					

* 12.75-13.25 GHz is paired with 10.7-10.95/11.2-11.45 GHz

1. A full description of the relationship between bands and services, as contained in related international and domestic footnotes, can be found in the Canadian Table of Frequency Allocations.
2. Fixed Service Use: 12.7-13.25 GHz Very High Capacity Microwave (VHCM), TV STL, TV Pick-up.
3. The first use of the fixed-satellite service in this band is foreseen in 13.0-13.15 GHz and 13.2-13.25 GHz for mobile satellite feeder links.
4. The use of this band by the fixed-satellite service or by any other fixed systems shall not prevent the use of these frequencies by existing or formally proposed VHCM stations used in conjunction with CATV systems, except as otherwise agreed.
5. TV Pick-ups shall not exceed an EIRP of 45 dBW.

14.5 - 15.35 GHz

Service	14.5	15.2	15.35
FIXED	LOW/MEDIUM CAPACITY		
Mobile	Government of Canada		
Space Research (passive) Earth Exploration- Satellite (passive)	[]		

1. A full description of the relationship between bands and services, as contained in related international and domestic footnotes, can be found in the Canadian Table of Frequency Allocations.
2. Fixed Service Use: 14.5-15.35 GHz Low and Medium Capacity Systems
3. Existing systems, which have been licensed previously as 'standard' may continue to operate with protection afforded to standard systems, until the equipment is retired. VHCM systems, previously licensed as standard, are eligible to expand under their original channelling arrangement.
4. The Government of Canada may operate fixed stations in specific sub-bands on a coordinated basis which may have transmission parameters different from those specified in the SRSP.
5. It should be noted that the band 14.7145-15.1365 is used by aeronautical mobile in the USA, which can be difficult to coordinate.
6. The band 14.875-14.975 GHz is available for TV Pick-ups.

17.7 - 19.7 GHz

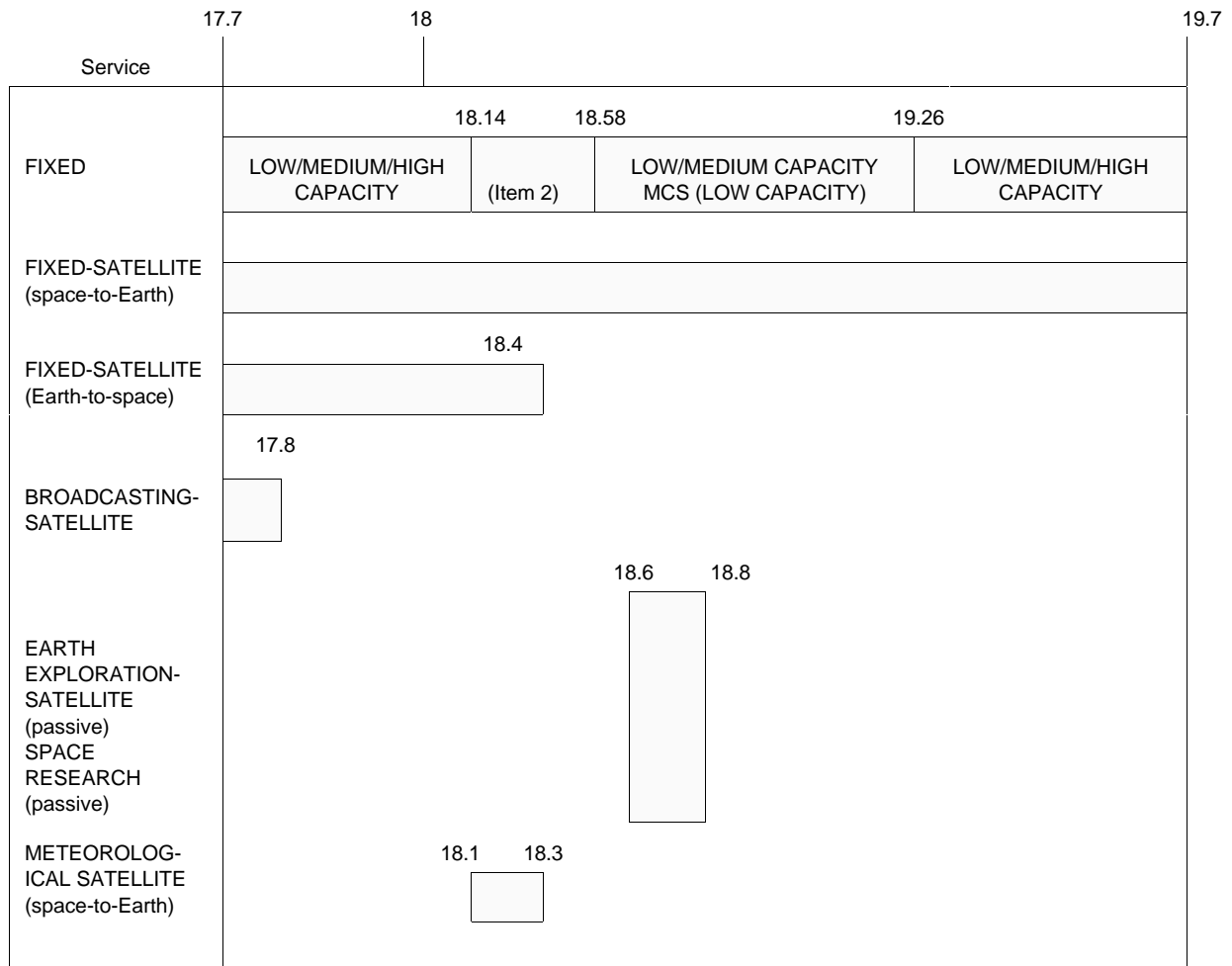

1. A full description of the relationship between bands and services, as contained in related international and domestic footnotes, can be found in the Canadian Table of Frequency Allocations.
2. Fixed Service Use:

17.7-18.14 GHz	Low, Medium and High Capacity Systems
19.26-19.7 GHz	Low, Medium and High Capacity Systems
18.14-18.58 GHz	Local MCS (e.g. video, data/text, voice), VHCM, TV STL, TV Pick-up
18.58-19.26 GHz	Low and Medium Capacity Systems, MCS (Low Capacity)
3. Users of the band 17.7-17.8 GHz for fixed systems will be able to operate until at least 1 April 2007. After that date, such systems may be required to retune to other portions of the 17.7-18.14 GHz and 19.26-19.7 GHz band.

21.2 - 23.6 GHz

Service	21.2	21.4	21.8	22	22.21	22.5	23	23.6	
FIXED	22.4								
	Item 3		Item 2			Item 3		Item 2	
INTER-SATELLITE							22.55	23.55	
EARTH EXPLORATION SATELLITE (passive) SPACE RESEARCH (passive)	[]		[]						
RADIO ASTRONOMY	[]								
Mobile				except Aero Mobile					

1. A full description of the relationship between bands and services, as contained in related international and domestic footnotes, can be found in the Canadian Table of Frequency Allocations.
2. Fixed Service Use: 21.8-22.4 GHz Low, Medium and High Capacity Systems
23.0-23.6 GHz Low, Medium and High Capacity Systems
3. The policy for the use of the 21.2-21.8 GHz and 22.4-23.0 GHz for fixed service is the subject of a policy review which includes other higher frequency bands.

3.0 Implementation

It is suggested that applicants contact the nearest office of Industry Canada regarding radio licensing in the bands covered in this policy document. General inquiries about the policy provisions contained in this document may be addressed to the Spectrum and Orbit Policy Directorate, Telecommunications Policy Branch, 300 Slater St., Ottawa, Ontario, K1A 0C8 (Phone: 613-998-4470/3974) (Fax: 613-952-0567).

Issued under the authority
of the Radiocommunication Act

Michael Helm
Director General
Telecommunications Policy Branch

Annex A

Excerpt of changes by the FCC to Part 21 of the Code of Federal Regulations

Section 21.710 Limitations on path lengths

- (a) The distance between end points of a fixed link must equal or exceed the value set forth in the table below or the EIRP must be reduced in accordance with the equation set forth below

Frequency Band (MHz)	Minimum path length (km)
Below 1, 850	n/a
1,850 to 7,125	17
10,550 to 13,250	5
Above 17,700	n/a

- (b) For paths shorter than those specified in the Table, the EIRP shall not exceed the value derived from the following equation.

$$\text{EIRP} = 30 - 20 \log[A/B], \text{ dBW}$$

Where:

EIRP = Equivalent isotropic radiated power in dBW.

A = Minimum path length from the Table for the frequency band in kilometres.

B = The actual path length in kilometres.

NOTE: Automatic transmit power control may be used to meet this requirement up to a 3 dB increase in EIRP.